

Plug and Play

Power it on with the included USB cable. Then connect your devices to the splitter via Ethernet cables and start using it immediately.

Notes:

1. You can connect your router/switch to any Ethernet port on the splitter. Make sure one of the ports is used for internet access.
2. This device is compatible with various network cables such as Cat 5/5e/6/7/8. To ensure stable network connection and transmission rate over medium and long distances, it is recommended to use Cat 5e and above.

User Guide

MEH35 1 to 3 Gigabit Ethernet Splitter

Images may differ from your actual product.

©2026 MERCUSYS REV1.0.0

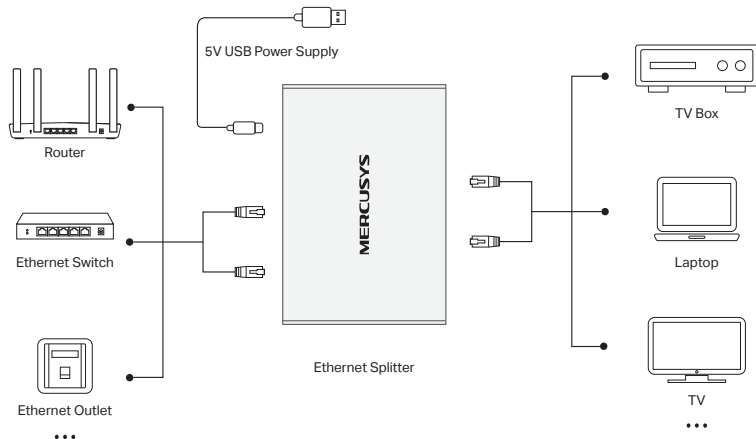

Product Overview

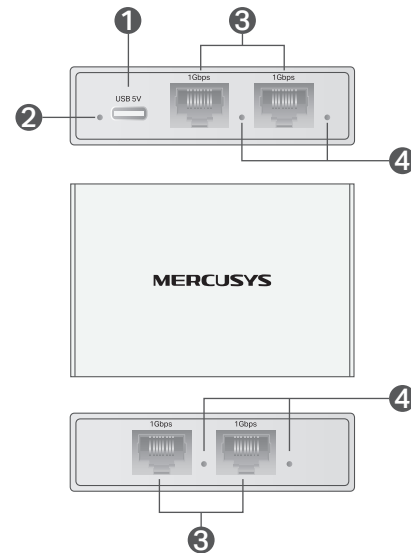

- 1 USB-C Port**
For charging via a USB power adapter, PC, laptop, etc.
* Does not support data transfer.
- 2 Power LED**
On: Power on
Off: Power off
- 3 Ethernet Port**
For connecting to your device such as switches, TVs, routers, computers, etc.
* The number of Ethernet ports may vary by product.
- 4 Ethernet Port LED**
On: Link present but no activity
Flashing: Transmitting/receiving data
Off: No link
* It might take a few seconds to light up after connected.

Troubleshooting

Q1. Why is the Power LED not lit?

The Power LED should be lit when the power system is working normally. If the Power LED is not lit, please try the following:

- Ensure the splitter is plugged in with a USB-C charging cable properly.
- Ensure the power supply's voltage meets the splitter's input voltage requirements.
- Ensure the power source is ON.

Q2. Why is the Ethernet Port LED not lit when a device is connected to the corresponding port?

- Ensure that the cable connectors are firmly plugged into the splitter and the device.
- Make sure the connected device is turned on and works normally.
- Try to change the connected device's transmission speed and duplex mode.
- The cable must be less than 100 meters long (328 feet).

Specifications

Standard	IEEE802.3, IEEE802.3i, IEEE802.3u, IEEE802.3ab, IEEE802.3x, IEEE802.1p
Protocol	CSMA/CD
Interface	1 Gbps Auto-Negotiation RJ45 Ports
LED Indicators	Power Port LED, RJ45 Ethernet Port LEDs
Data Transfer Rate	1000 Mbps, backward compatibility with 100 Mbps/10 Mbps *Gigabit Ethernet: 2000 Mbps (Full Duplex)
Operating Temperature	0 °C to 40 °C (32 °F to 104 °F)
Operating Humidity	10% to 90% RH non-condensing
Storage Humidity	5% to 90% RH non-condensing
Transfer Method	Store-and-Forward
MAC Address Learning	Automatically learning, automatically aging
Frame Forward Rate	10Base-T: 14881 pps/Port 100Base-Tx: 148810 pps/Port 1000Base-T: 1488095 pps/Port
USB-C Input	5V 0.3A

Package Content	1 × Ethernet Splitter 1 × USB Power Cable Quick Installation Guide
-----------------	--

Support

 For technical support, the user guide and more information, please visit <https://www.mercusys.com/support>.

Safety Information

• When the product has a power button, the power button is one of the ways to shut off the product; when there is no power button, the only way to completely shut off power is to disconnect the product or the power adapter from the power source.

• Keep the device away from water, fire, humidity or hot environments.

• Do not attempt to disassemble, repair, or modify the device. If you need service, please contact us.

• This equipment can be powered only by equipments that comply with Power Source Class 2 (PS2) or Limited Power Source (LPS) defined in the standard of IEC 62368-1.

MERCUSYS hereby declares that the 1 to 3 Gigabit Ethernet Splitter is in compliance with the essential requirements and other relevant provisions of directives 2014/30/EU, 2011 /65/EU and (EU) 2015/863. The original EU Declaration of Conformity may be found at <https://www.mercusys.com/en/ce>

MERCUSYS hereby declares that the 1 to 3 Gigabit Ethernet Splitter is in compliance with the essential requirements and other relevant provisions of the Electromagnetic Compatibility Regulations 2016. The original UK Declaration of Conformity may be found at <https://www.mercusys.com/support/ukca/>



Operating Temperature: 0°C~40°C (32°F~104°F),
Storage Temperature: -40°C~60°C (-40°F ~140°F)

運作溫度: 0°C~40°C (32°F~104°F)

安全諮詢及注意事項

- 請使用原裝電源供應器或只能按照本產品注明的電源類型使用本產品。
- 清潔本產品之前請先拔掉電源線。請勿使用液體、噴霧清潔劑或濕布進行清潔。
- 注意防潮, 請勿將水或其他液體潑灑到本產品上。
- 插槽與開口供通風使用, 以確保本產品的操作可靠並防止過熱, 請勿堵塞或覆蓋開口。
- 請勿將本產品置放於靠近熱源的地方。除非有正常的通風, 否則不可放在密閉位置中。
- 不要私自拆開機殼或自行維修, 如產品有故障請與原廠或代理商聯繫。

Authentication

限用物質含有情況標示聲明書

設備名稱 Equipment name: 1 to 3 Gigabit Ethernet Splitter 型號 (型式) Type designation (Type): MEH35						
單元 Unit	限用物質及其化學符號 Restricted substances and its chemical symbols					
	鉛 Lead (Pb)	汞 Mercury (Hg)	鎘 Cadmium (Cd)	六價鉻 Hexavalent chromium (Cr+6)	多溴聯苯 Polybrominated biphenyls (PBB)	多溴二苯醚 Polybrominated diphenyl ethers (PBDE)
PCB	○	○	○	○	○	○
外殼	○	○	○	○	○	○
塑料組件	○	○	○	○	○	○
其他及其配件	-	○	○	○	○	○
備考1. “超出0.1 wt %”及“超出0.01 wt %”係指限用物質之百分比含量超出百分比含量基準值。 Note 1: “Exceeding 0.1 wt %” and “exceeding 0.01 wt %” indicate that the percentage content of the restricted substance exceeds the reference percentage value of presence condition.						
備考2. “○”係指該項限用物質之百分比含量未超出百分比含量基準值。 Note 2: “○” indicates that the percentage content of the restricted substance does not exceed the percentage of reference value of presence.						
備考3. “-”係指該項限用物質為排除項目。 Note 3: The “-” indicates that the restricted substance corresponds to the exemption.						









產品標籤上符號的解釋

設備標記位於設備底部。符號可能因產品而異。

	僅供室內使用
	DC電壓
	交流電
	回收 這個產品帶有歐盟指令2012/19/EU中關於廢棄電氣電子設備 (WEEE) 的選擇性分類標誌。這意味著，該產品必須按照該指令處理，以便進行回收或拆解，從而最大限度地減少對環境的影響。用戶可以選擇將產品交給有資格的回收機構，或在購買新的電器或電子設備時將其交給零售商進行回收。
	能源效率標誌 (level VI)
	輸出端點的極性
	二級設備
	警告
	操作手冊

Explanation of the symbols on the product label

The equipment marking is at the bottom of the device. Symbols may vary from products.

	Indoor use only
	DC voltage
	AC voltage
	RECYCLING This product bears the selective sorting symbol for Waste electrical and electronic equipment (WEEE). This means that this product must be handled pursuant to European directive 2012/19/EU in order to be recycled or dismantled to minimize its impact on the environment. User has the choice to give his product to a competent recycling organization or to the retailer when he buys a new electrical or electronic equipment.
	Energy efficiency marking (level VI)
	Polarity of output terminals
	Class II equipment
	Caution
	Operator's manual



Продукт сертифіковано згідно з правилами системи УкрСЕПРО на відповідність вимогам нормативних документів та вимогам, що передбачені чинними законодавчими актами України.

