

MERCUSYS®

User Guide

AXE5400 Wi-Fi 6E Bluetooth PCIe Adapter

MA86XE

REV1.0.0
1910080121

COPYRIGHT & TRADEMARK

Specifications are subject to change without notice. **MERCUSYS**[®] is a registered trademark of MERCUSYS TECHNOLOGIES CO., LTD. Other brands and product names are trademarks or registered trademarks of their respective holders.

No part of the specifications may be reproduced in any form or by any means or used to make any derivative such as translation, transformation, or adaptation without permission from MERCUSYS TECHNOLOGIES CO., LIMITED. Copyright © 2024 MERCUSYS TECHNOLOGIES CO., LIMITED. All rights reserved.

<http://www.mercusys.com>

CE Mark Warning



This is a class B product. In a domestic environment, this product may cause radio interference, in which case the user may be required to take adequate measures.

OPERATING FREQUENCY (the maximum transmitted power)

2400MHz-2483.5MHz(20dBm)

5150MHz-5250MHz(23dBm)

5250MHz-5350MHz(23dBm)

5470MHz-5725MHz(23dBm)

5945MHz-6425MHz(23dBm)

RF Exposure Information

This device meets the EU requirements (2014/53/EU Article 3.1 a) on the limitation of exposure of the general public to electromagnetic fields by way of health protection.

The device complies with RF specifications when the device used at 20 cm from your body.

Frequency band: 5150 - 5250 MHz:

Indoor use: Inside buildings only. Installations and use inside road vehicles and train carriages are not permitted. Limited outdoor use: If used outdoors, equipment shall not be attached to a fixed installation or to the external body of road vehicles, a fixed infrastructure or a fixed outdoor antenna. Use by unmanned aircraft systems (UAS) is limited to within the 5170 - 5250 MHz band.

Frequency band: 5250 - 5350 MHz:

Indoor use: Inside buildings only. Installations and use in road vehicles, trains and aircraft are not permitted. Outdoor use is not permitted.

Frequency band: 5470 - 5725 MHz:

Installations and use in road vehicles, trains and aircraft and use for unmanned aircraft systems (UAS) are not permitted.

Frequency band: 5945 - 6425 MHz:

Restricted to indoor use, including in trains with metal-coated windows and aircraft. Outdoor use, including in road vehicles, is not permitted.

	AT	BE	BG	CH	CY	CZ	DE	DK
	EE	EL	ES	FI	FR	HR	HU	IE
	IS	IT	LI	LT	LU	LV	MT	NL
	NO	PL	PT	RO	SE	SI	SK	UK(NI)

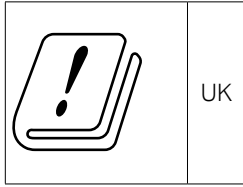

Attention: This device may only be used indoors in Great Britain.

EU declaration of conformity

Mercusys hereby declares that the device is in compliance with the essential requirements and other relevant provisions of directives 2014/53/EU, 2011 /65/EU and (EU) 2015/863.

The original EU declaration of conformity may be found at <https://www.mercusys.com/en/ce/>

UK declaration of conformity



Mercusys hereby declares that the device is in compliance with the essential requirements and other relevant provisions of the Radio Equipment Regulations 2017.

The original UK declaration of conformity may be found at <https://www.mercusys.com/support/ukca/>

Korea Warning Statements

당해 무선설비는 운용중 전파혼신 가능성이 있음.

NCC Notice

注意!

取得審驗證明之低功率射頻器材，非經核准，公司、商號或使用者均不得擅自變更頻率、加大功率或變更原設計之特性及功能。

低功率射頻器材之使用不得影響飛航安全及干擾合法通信；經發現有干擾現象時，應立即停用，並改善至無干擾時方得繼續使用。

前述合法通信，指依電信管理法規定作業之無線電通信。

低功率射頻器材須忍受合法通信或工業、科學及醫療用電波輻射性電機設備之干擾。

應避免影響附近雷達系統之操作。

高增益指向性天線只得應用於固定式點對點系統。

BSMI Notice

· 請使用原裝電源供應器或只能按照本產品注明的電源類型使用本產品。

- 清潔本產品之前請先拔掉電源線。請勿使用液體、噴霧清潔劑或濕布進行清潔。
- 注意防潮，請勿將水或其他液體潑灑到本產品上。
- 插槽與開口供通風使用，以確保本產品的操作可靠並防止過熱，請勿堵塞或覆蓋開口。
- 請勿將本產品置放於靠近熱源的地方。除非有正常的通風，否則不可放在密閉位置中。
- 不要私自拆開機殼或自行維修，如產品有故障請與原廠或代理商聯繫。

限用物質含有情況標示聲明書

Equipment name 設備名稱：AXE5400 Wi-Fi 6E Bluetooth PCIe Adapter		型號（型式）：MA86XE				
單元 Unit	限用物質及其化學符號 Restricted substances and its chemical symbols					
	鉛 Lead (Pb)	汞 Mercury (Hg)	鎘 Cadmium (Cd)	六價鉻 Hexavalent chromium (Cr ⁺⁶)	多溴聯苯 Polybrominated biphenyls (PBB)	多溴二苯醚 Polybrominated diphenyl ethers (PBDE)
PCB	○	○	○	○	○	○
外殼	○	○	○	○	○	○
天線	○	○	○	○	○	○
其他及其 配件	—	○	○	○	○	○
<p>備考 1. “超出 0.1 wt %” 及 “超出 0.01 wt %” 係指限用物質之百分比含量超出百分比含量基準值 Note 1: “Exceeding 0.1 wt %” and “exceeding 0.01 wt %” indicate that the percentage content of the restricted substance exceeds the reference percentage value of presence condition.</p> <p>備考 2. “○” 係指該項限用物質之百分比含量未超出百分比含量基準值。 Note 2: “○” indicates that the percentage content of the restricted substance does not exceed the percentage of reference value of presence.</p> <p>備考 3. “—” 係指該項限用物質為排除項目。 Note 3: The “—” indicates that the restricted substance corresponds to the exemption.</p>						



Продукт сертифіковано згідно с правилами системи УкрСЕПРО на відповідність вимогам нормативних документів та вимогам, що передбачені чинними законодавчими актами України.

EAC



Safety Information

- Keep the device away from water, fire, humidity or hot environments.
- Do not attempt to disassemble, repair, or modify the device. If you need service, please contact us.
- Do not use the device where wireless devices are not allowed.
- This equipment can be powered only by equipments that comply with Power Source Class 2 (PS2) or Limited Power Source(LPS) defined in the standard of IEC 62368-1.

Please read and follow the above safety information when operating the device. We cannot guarantee that no accidents or damage will occur due to improper use of the device. Please use this product with care and operate at your own risk.







This product uses radios and other components that emit electromagnetic fields. Electromagnetic fields and magnets may interfere with pacemakers and other implanted medical devices. Always keep the product and its power adapter more than 15 cm (6 inches) away from any pacemakers or other implanted medical devices. If you suspect your product is interfering with your pacemaker or any other implanted medical device, turn off your product and consult your physician for information specific to your medical device.















Environment



Operating Temperature: 0°C ~40°C (32 °F ~104 °F)

Explanation of the symbols on the product label

Symbols may vary from products.

Symbol	Explanation
	Class II equipment
	Class II equipment with functional earthing
	Alternating current
	Direct current
	Polarity of d.c. power connector
	Indoor use only
	Dangerous voltage

	Caution, risk of electric shock
	Energy efficiency Marking
	Protective earth
	Earth
	Frame or chassis
	Functional earthing
	Caution, hot surface
	Caution
	Operator's manual
	Stand-by
	"ON"/"OFF" (push-push)
	Fuse
	Fuse is used in neutral N
	<p>RECYCLING</p> <p>This product bears the selective sorting symbol for Waste electrical and electronic equipment (WEEE). This means that this product must be handled pursuant to European directive 2012/19/EU in order to be recycled or dismantled to minimize its impact on the environment.</p> <p>User has the choice to give his product to a competent recycling organization or to the retailer when he buys a new electrical or electronic equipment.</p>

	<p>Caution, avoid listening at high volume levels for long periods</p>
	<p>Disconnection, all power plugs</p>
<p>m</p>	<p>Switch of mini-gap construction</p>
<p>μ</p>	<p>Switch of micro-gap construction (for US version) Switch of micro-gap / micro-disconnection construction (for other versions except US)</p>
<p>ε</p>	<p>Switch without contact gap (Semiconductor switching device)</p>

CONTENTS

Conventions	01
Chapter 1 Introduction	02
Product Overview	02
1.1 Features	02
Chapter 2 Installation Guide	03
2.1 Hardware Connection	03
2.2 Driver Installation	04
Chapter 3 Connect to a Wireless Network	06
Chapter 4 Pair With Bluetooth Devices	07
Chapter 5 Uninstall Driver	08
Appendix: Specifications	09

Conventions

The Adapter or MA86XE, or device mentioned in this User Guide stands for MA86XE AXE5400 Wi-Fi 6E Bluetooth 5.3 PCIe Adapter without any explanations.

Note: Features of the adapter may vary by model and driver version. All images, steps, and descriptions in this guide are only examples and may not reflect your actual adapter experience.

More Info

Specifications and the latest software can be found at the product page at the official website <http://www.mercusys.com>.

The Quick Installation Guide can be found where you find this guide or inside the package of the router.

Speed/Coverage Disclaimer

†Maximum wireless signal rates are the physical rates derived from IEEE Standard 802.11 specifications. Actual wireless data throughput and wireless coverage, and number of connected devices are not guaranteed and will vary as a result of network conditions, AP limitations, and environmental factors, including building materials, obstacles, volume and density of traffic, and AP location.

‡Use of Wi-Fi 6, Wi-Fi 6E(802.11ax), and features including OFDMA, MU-MIMO, 1024-QAM, or HE160 requires APs to also support the corresponding features. 160 MHz channels may not be all available in the 5 GHz or 6 GHz band in some regions/ countries due to regulatory restrictions.

^Functionality of MA86XE may be restricted on some computing systems and platforms. Please try to update the device's driver for feature compatibility.

§Use of WPA3 requires APs to also support WPA3.

*Several new features are introduced in the Bluetooth Core Specification 5.0, 5.2 and 5.3 Release, including 2× faster speed and 4× broader coverage compared with Bluetooth 4.2.

Chapter 1 Introduction

1.1 Product Overview

MA86XE arms your PC with Wi-Fi 6E technology and the brand-new 6 GHz band, unlocking your Wi-Fi 6E router's full potential. Experience the unblocked network on the exclusive band to Wi-Fi 6E devices, which prevents drops in speed and interference from legacy devices.

Note: Please note: MA86XE is not compatible with the low-profile bracket because of the fixed antennas.



1.2 Features

- Unstoppable Tri-Band Speed — Speeds up to 2402 Mbps (6 GHz) + 2402 Mbps (5 GHz) + 574 Mbps (2.4 GHz)
- WiFi 6E Standard — Expand to the clearer, broader 6 GHz band
- Wider Signal Coverage — Two high-performance antennas
- Bluetooth 5.3 — The latest Bluetooth technology achieves faster speeds and broader coverage
- Improved Security — The latest security enhancement, WPA3, provides enhanced protection in personal password safety
- Backward Compatibility — Full support for 802.11 ax/ac/a/b/g/n standards
- Windows Compatible — Supported operating system: Windows 10, 11 (64 bit), and currently 6 GHz Band only supported on Windows 11.

Chapter 2 Installation Guide

Before You Start

If you plan on using Bluetooth and already have connected Bluetooth devices, proceed with Step 1. Otherwise, **skip to Step 2**.

1. Disable your Bluetooth

- Right-click My Computer, select **Manage**, go to Device Manager.
- Expand the **Bluetooth** node to find your existing Bluetooth device.
- Right-click the existing Bluetooth device and select **Disable**.

Note:

Make sure you have disabled all existing Bluetooth devices (both built-in and third party).

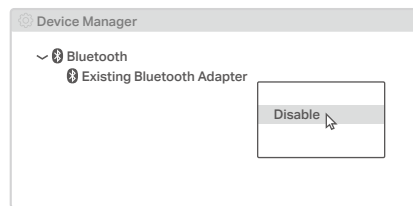

2. Hardware Connection

- Turn off your computer, unplug the power cable then remove the case panel.

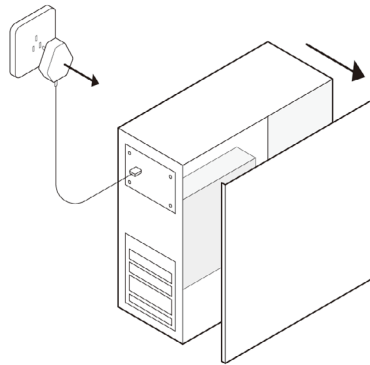

- Connect the provided Bluetooth USB cable to the adapter.

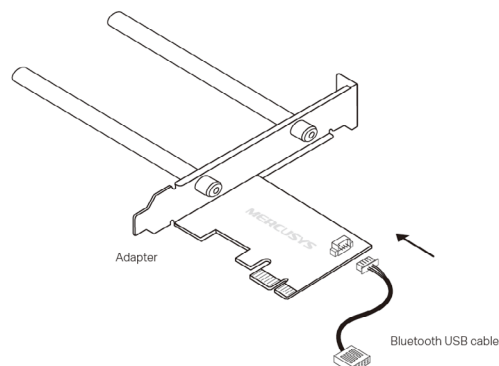

3. Locate an available **PCI-E** slot (X1, X4, X8, or X16) and remove the corresponding slot cover on the rear panel. Then insert the adapter carefully.

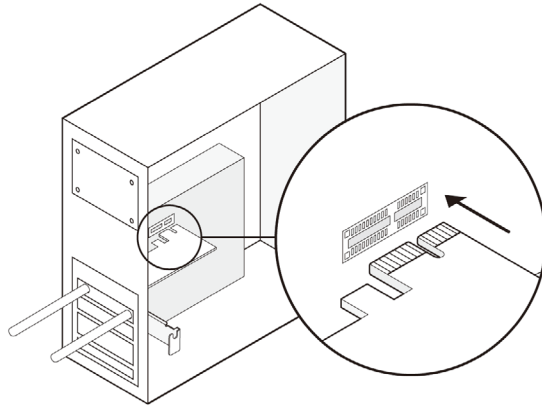

4. Locate an available **9-pin** connector and carefully plug the Bluetooth USB cable into it.

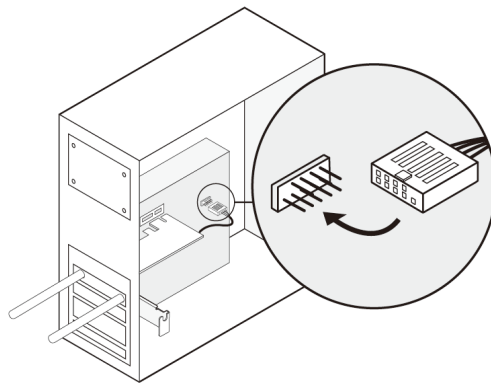

Note:

If the Bluetooth USB cable is not correctly connected to the motherboard, Bluetooth function won't work even after driver installation.

5. Replace the case panel, plug in the power cable and turn on your computer.

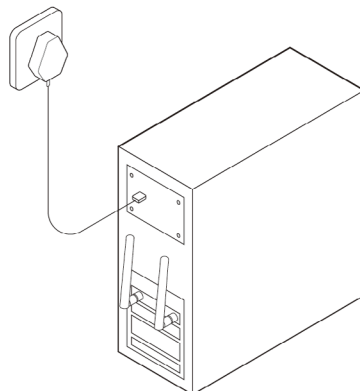

2.3 Driver Installation



The following instructions take Windows 10 as an example. The steps may vary slightly from other versions of Windows.

1. Insert the CD and run the **Autorun.exe**.

Tip:

You can also check the new release and download the driver at www.mercusys.com/support.

2. Install the Wi-Fi and Bluetooth drivers.

- a. **Wi-Fi:** Click  and follow the onscreen instructions to complete the Wi-Fi installation.
- b. **Bluetooth:** Click  and follow the onscreen instructions to complete the Wi-Fi installation.

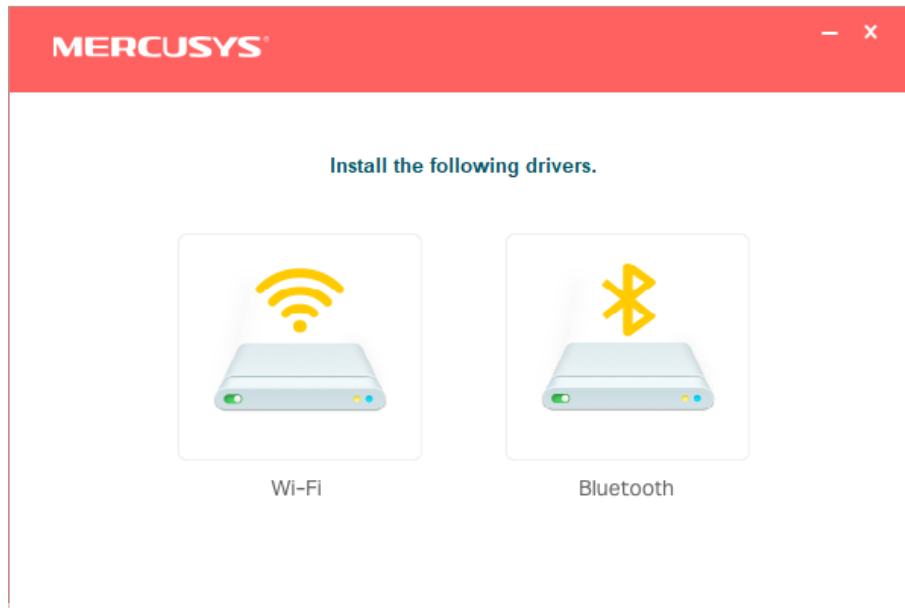

Note:

DO NOT run the driver installations at the same time. When one driver is being installed, please wait until the installation is complete and then try to install the other.

Chapter 3 Connect to a Wireless Network

With both the hardware and software successfully installed into your computer, you can quickly connect to a wireless network via Windows wireless utility.

The following instructions take Windows 10 as an example. The steps may vary slightly from other versions of Windows.

Connect to a Wireless Network

1. Click the network icon () on the taskbar. Select your Wi-Fi network, click **Connect**, and enter the password when prompted.
2. When **Connected** displays next to the network name (SSID) on the screen, it indicates a successful network connection.

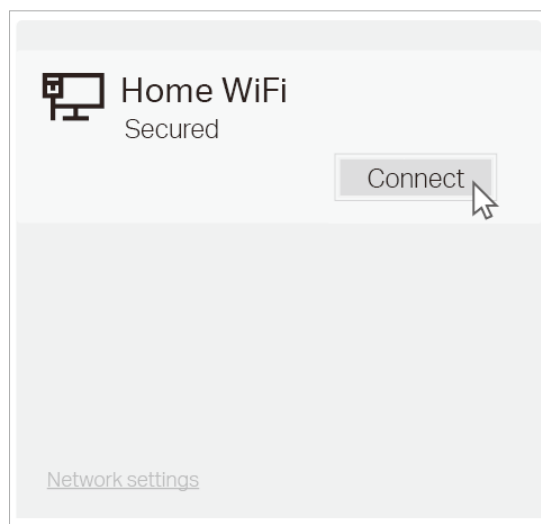

Chapter 4 Pair With Bluetooth Devices

MA86XE makes your PC Bluetooth-capable with ultra-fast Bluetooth 5.3 which achieves more stable connection, farther range and faster transmission speeds than Bluetooth 4. Just connect your Bluetooth devices to your computer and enjoy with ease.

Pair With Bluetooth Devices

1. Right click the  (Bluetooth) icon on the taskbar. If it's not displayed, turn on Bluetooth in your PC settings first.
2. Select **Add a Bluetooth Device** or **Add a Device** to scan for available devices.
3. Select your Bluetooth device from the list and follow the onscreen instructions to complete pairing.

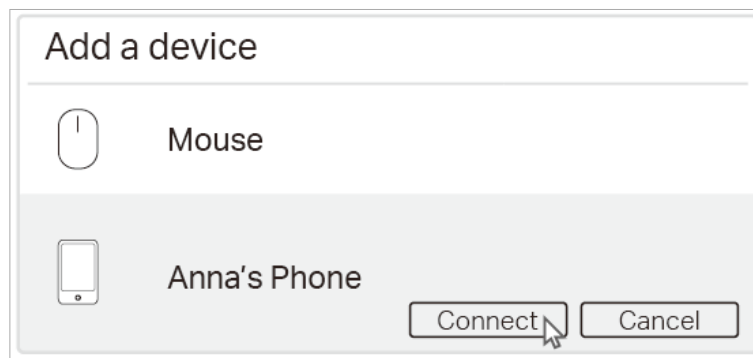

Note:

Make sure your device's Bluetooth is enabled and discoverable.

Chapter 5 Uninstall Driver

You can remove the driver from **Windows Control Panel**.

- **Uninstall Wi-Fi driver**

1. Start **Control Panel**, go to **Programs and Features**, click **Uninstall a program**.
2. Find and uninstall the Mercusys program **MERCUSYS MA86XE Wi-Fi Driver**.
3. Follow the on-screen instructions to complete the uninstallation.
4. Restart your computer.

- **Uninstall Bluetooth driver**

1. Start **Control Panel**, go to **Programs and Features**, click **Uninstall a program**.
2. Find and uninstall the Mercusys program **MERCUSYS MA86XE Bluetooth Driver**.
3. Follow the on-screen instructions to complete the uninstallation.
4. Restart your computer.

Appendix: Specifications

Normal	
Wireless Standards	IEEE 802.11a/b/g/n/ac/ax
Wi-Fi Speeds	2402 Mbps on 6 GHz 2402 Mbps on 5 GHz 574 Mbps on 2.4 GHz
Reception Sensitivity	6 GHz: 11ax HE160 MCS0:-86 dBm 11ax HE160 MCS11:-56 dBm 5 GHz: 11ax HE80 MCS0: -90 dBm 11ax HE80 MCS11: -59 dBm 11a 54Mbps: -77 dBm 11ac VHT80 MCS0: -92dBm 11ac VHT80 MCS9: -64dBm 2.4 GHz: 11ax HE40 MCS0: -91 dBm 11ax HE40 MCS11: -60 dBm 11g 54Mbps: -76 dBm 11n HT40 MCS7: -72dBm
Wireless Security	WPA-PSK/WPA2-PSK/ WPA3-SAE**
Dimensions	226.3 × 120.8 × 21.5 mm (8.9 × 4.8 × 0.85 in)
Antenna Type	2× Fixed High-Performance Omni-Directional Antennas
System Requirements	Windows 10/11(64-bit)

Environmental and Physical	
Operating Temperature	0°C~40°C (32°F~104°F)
Operating Humidity	10%~90% Non-Condensing
Storage Humidity	5%~90% Non-Condensing