

# Quick Installation Guide

Wireless Access Point

Note: AP9650 is used as an example throughout the Guide. Images may differ from your actual product.  
©2023 TP-Link 7106510783 REV1.2.1

## 1 Hardware Overview

### Front Panel

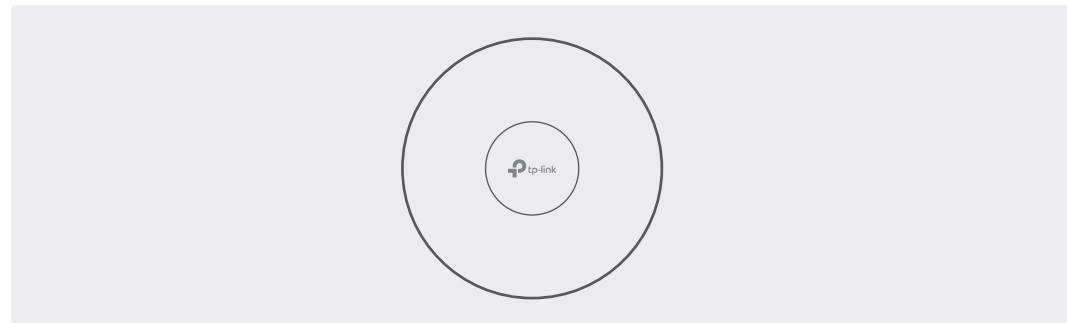

### LED Indicator

- Blue On:** Working normally/initializing. For APs with dual-color LED: Normal power supply
- Orange On:** For APs with dual-color LED: Low power supply
- Off:** Working abnormally/Power off/LED is turned off.
- Flash:**
  - Flash twice: Initialization is completed.
  - Flash once per second: The AP is upgrading.
  - Flash quickly: The AP is resetting or the controller is locating the AP\*.
  - Flash slowly: The AP is in the isolated state.

\* When the Locate feature is activated in the controller, the LED flashes quickly to locate and identify the device. The LED will flash for 10 minutes, or you can disable the feature manually to stop it flashing.

### Rear Panel

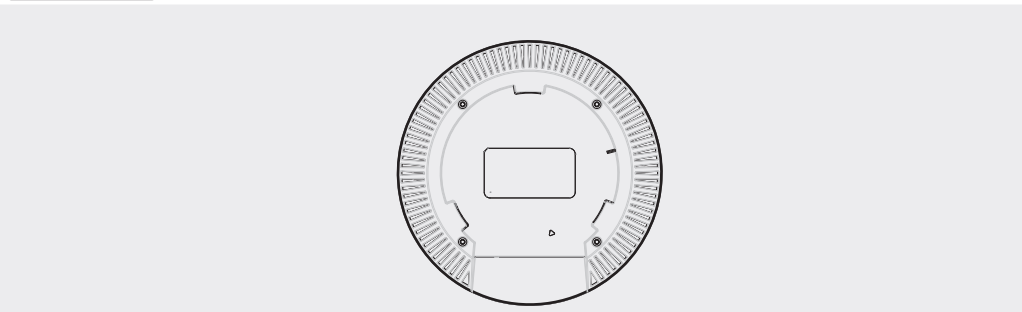

### RESET

With the device powered on, press and hold the button for about 5 seconds until the LED flashes quickly. Then release the button. The device will restore to factory default settings.

### Ethernet Port (PoE)

The port is used to connect to a router or a switch to transmit data, or to a PSE (Power Sourcing Equipment), such as a PoE switch, for both data transmission and Power over Ethernet (PoE) through Ethernet cable.

### Ethernet Port (for certain models)

The port is used to connect to a wired device.

### Power Port

Plug one end of the power adapter to this port and the other end to a standard electrical wall outlet to power the AP.  
Note: Power adapter is not provided. For power supply specifications, please refer to the label at the bottom of the product.

## 2 Hardware Installation

The AP can be mounted to the ceiling, the wall, or in a junction box, using the screws in the package. Choose the appropriate mounting and installation steps below.  
Note: This product requires heat dissipation through the metal bracket during use, please be careful not to touch the metal bracket in the heat dissipation.

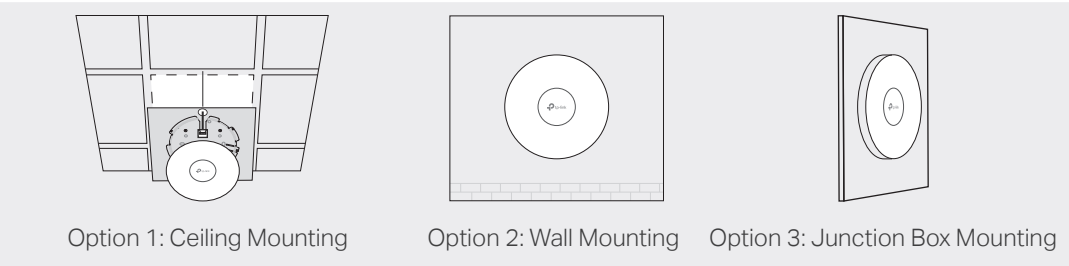

### Option 1: Ceiling Mounting

Note: Make sure that the ceiling tile is larger than the AP.

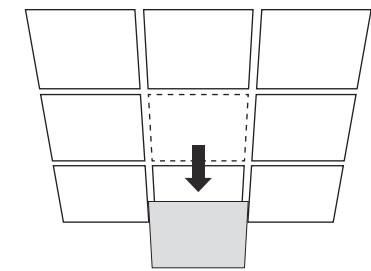
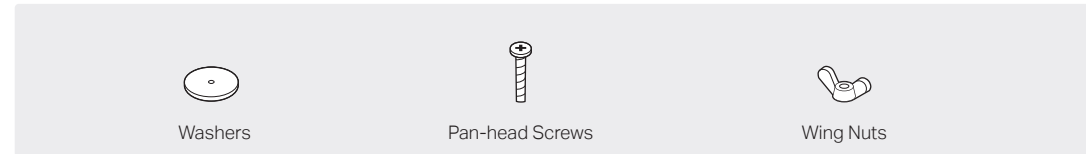

1 Remove the ceiling tile.

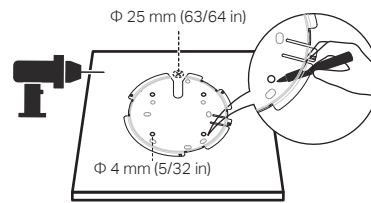

2 Place the mounting bracket in the center of the ceiling tile. Mark positions for the screw holes and a location for the Ethernet cable hole. Drill holes for the screws and a hole for the Ethernet cable at the marked positions.

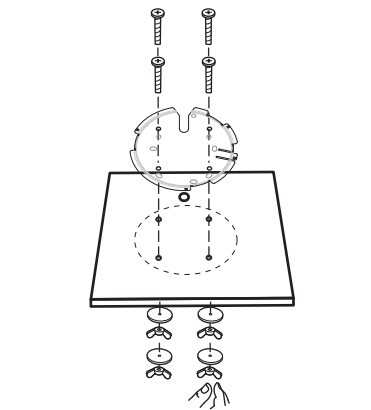

3 Secure the mounting bracket to the ceiling tile using pan-head screws, washers, and wing nuts, as shown on the left.

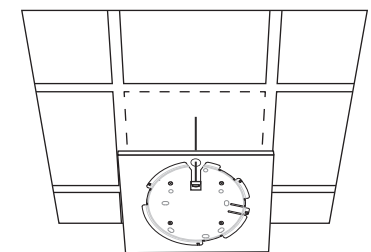

4 Feed the Ethernet cable through the hole and set the ceiling tile back into place.

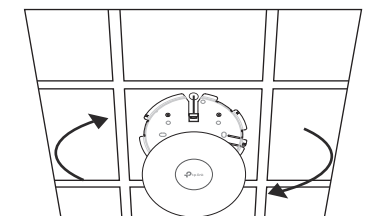

5 Connect the Ethernet cable to the Ethernet port. Please pay attention to the triangle sign. Attach the AP to the mounting bracket, then rotate it until it locks into place, as shown on the left.

### Option 2: Wall Mounting

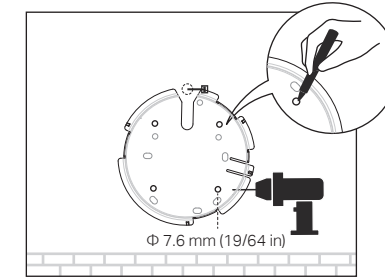
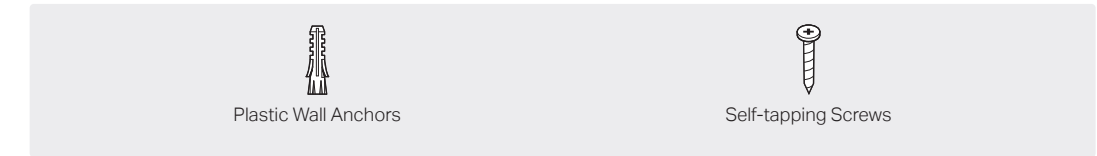

1 If your Ethernet cable feeds through the wall, position the mounting bracket below the cable hole. Mark positions for the screw holes and drill holes at the marked positions.

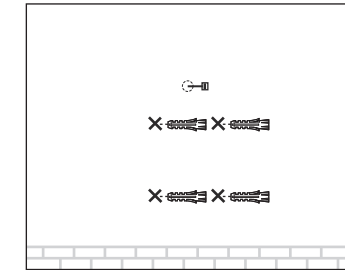

2 Insert the plastic wall anchors into the holes.

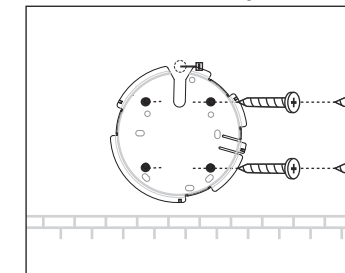

3 Secure the mounting bracket to the wall by driving the self-tapping screws into the anchors. Make sure that the shoulders of the mounting bracket are on the outside.

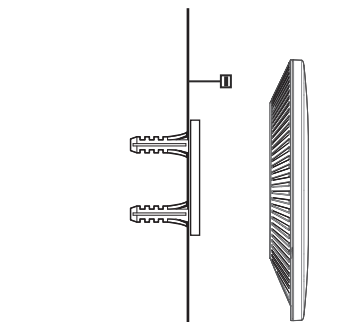

4 Connect the Ethernet cable to the Ethernet port on the AP.

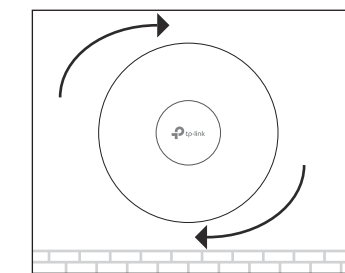

5 Attach the AP to the mounting bracket by rotating it until it locks into place, as shown on the left.

### Option 3: Junction Box Mounting

Prepare the cables and the junction box in advance. Ensure that the mounting holes align to your junction box.

\*Compatible wall junctions:

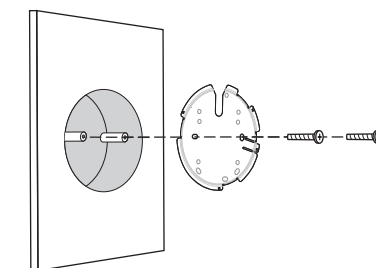

Route the cables through the square cable hole on the mounting bracket, and secure the mounting bracket to the junction box using screws. Then follow Step 4 and Step 5 of Option 2 to complete the installation.

### 3 Power Supply

The AP can be powered via a power adapter or a PSE device (such as a PoE switch) which complies with Power Source Class 2 (PS2) or Limited Power Source (LPS) of IEC 62368-1.

#### Option 1: Via PoE Switch

Connect an Ethernet cable from the PoE switch to the Ethernet port of the AP.

Note: For PoE power supply specifications, refer to the label at the bottom of the product.

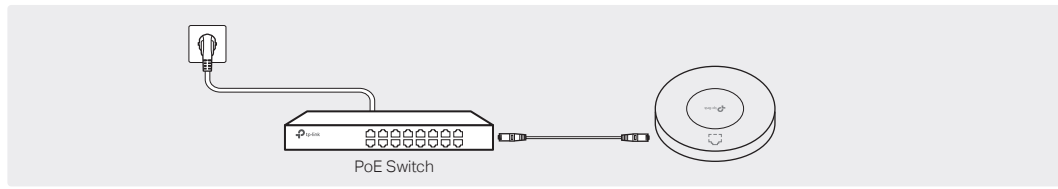

#### Option 2: Via Power Adapter

Plug one end of the power adapter into the power port of the AP and the other end to a standard electrical wall outlet.

Note: Power adapter is not provided. For power supply specifications, refer to the label at the bottom of the product.

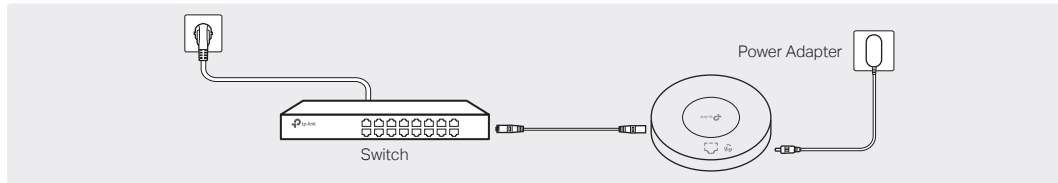

### 4 Software Configuration

Choose from the following methods to set up your APs:

- **Method 1: Standalone Mode**  
To configure and manage APs separately (Convenient for a small network with only a few devices)
- **Method 2: Controller Mode**  
To configure and manage APs in batches on a central platform, namely the controller.

#### Method 1: Standalone Mode

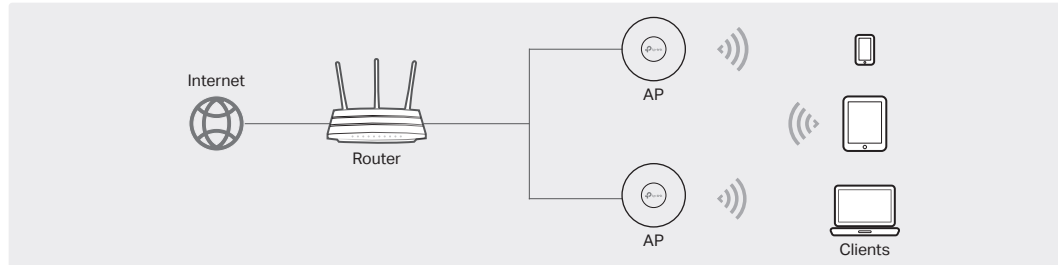

- Note:**
- Before you start, be sure to **power up** and **connect** your devices according to the topology figure.
  - A **DHCP server** (typically a router with DHCP function enabled) is required to assign IP addresses to the APs and clients in your local network.

#### Via Omada App

1. Download and install the TP-Link Omada app from App Store or Google Play.

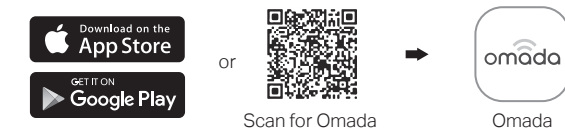

2. Connect your mobile device to the AP by using the default SSIDs printed on the label at the bottom of the product.
3. Open the Omada app, go to the **Standalone Devices > APs** page, and wait for the AP to appear. Tap on the AP to configure it.

The Omada app is designed to help you quickly configure common settings. If you want to configure advanced settings, use the web page of your AP or use Controller Mode.

#### Via Web Browser

1. Connect your device to the AP by using the default SSIDs printed on the label at the bottom of the product.
2. Launch a web browser and enter <http://tplinkeap.net> in the address bar. Use **admin** for both Username and Password to log in.
3. Set up a new Username and Password for secure management purpose. Then you can configure the AP.

To configure other APs, connect your device to each AP by using the corresponding default SSIDs and repeat the steps above. You can configure some basic functions in Standalone Mode. If you want to configure advanced functions, use Controller Mode.

### Method 2: Controller Mode

Choose a type of controller:

- **Type 1: Omada Pro Software Controller**

If you want to use the software controller, get a PC with Windows or Linux OS, contact the sales staff to get the installation package of Omada Pro Software Controller, then install and launch it.

To manage your devices, the software controller needs to keep running on your computer. Licenses need to be purchased additionally.

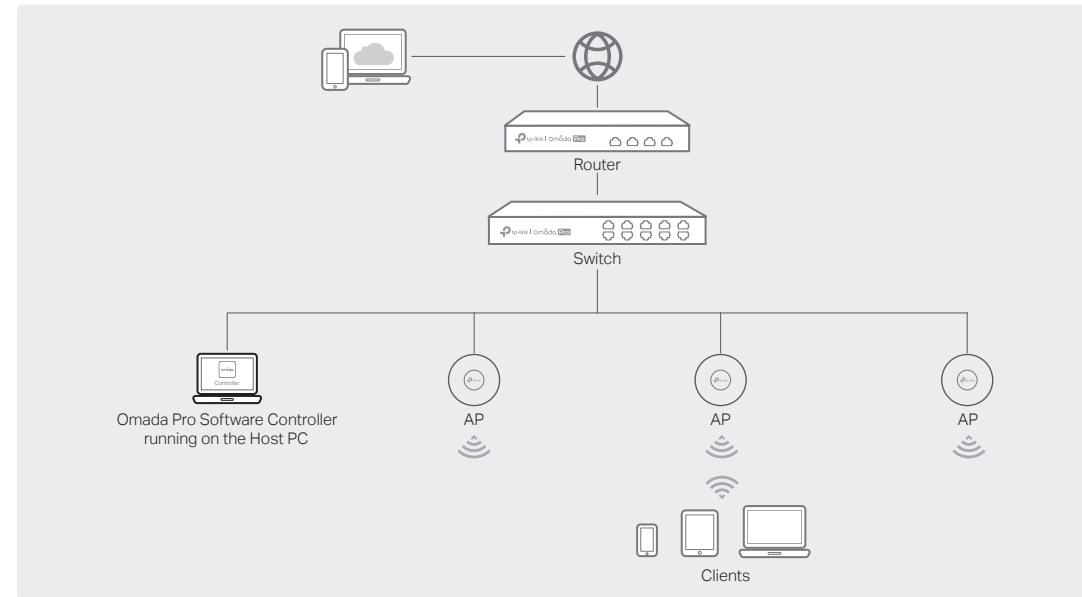

- Note:**
- Before you start, be sure to **power up** and **connect** your devices according to the topology figure.
  - A **DHCP server** (typically a router with DHCP function enabled) is required to assign IP addresses to the APs and clients in your local network.
  - The controller must have network access to your devices (the router, switch, and APs) in order to find, adopt, and manage them.

#### Via Omada App

1. Download and install the TP-Link Omada app from App Store or Google Play.

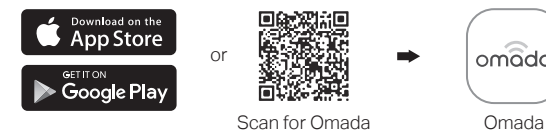

2. Launch your Omada app and configure the controller at a local or remote site.

- **Local Management**
  - a. Connect your mobile device to the AP by using the default SSIDs printed on the label at the bottom of the product.
  - b. Launch the Omada app and go to **Local Access**, tap the + button on the upper-right corner to add the controller. Then you can launch the controller to adopt and manage devices.
- **Remote Management**

**Note:** Before you start, make sure that both your controller and mobile device can access the internet.

  - a. Make sure that **Cloud Access** is enabled on your controller and your controller has been bound with your TP-Link ID.
  - b. Launch the Omada app and log in with your TP-Link ID. Then go to **Cloud Access**. A list of controllers that have been bound with your TP-Link ID will appear. Then you can launch the controller to adopt and manage devices.

#### Via Web Browser

- **Local Management**
  - a. Launch the software controller on your PC. After the initiation process, the controller automatically opens its web page. If not, click **Launch a Browser to Manage the Network**.
  - b. On the controller's web page, follow the wizard to complete the quick setup. Then you can launch the controller to adopt and manage devices.
- **Remote Management**

**Note:** Before you start, make sure that both your controller and PC can access the internet.

  - a. Make sure that **Cloud Access** is enabled on your controller and your controller has been bound with your TP-Link ID.
  - b. Launch a web browser and enter <https://omada.tplinkcloud.com> in the address bar. Log in with your TP-Link ID. A list of controllers that have been bound with your TP-Link ID will appear. Then you can launch the controller to adopt and manage devices.

- **Type 2: Omada Pro Cloud-Based Controller**

Omada Pro Cloud-Based Controller is a good alternative without the need to install the software controller on a PC.

Licenses need to be purchased additionally.

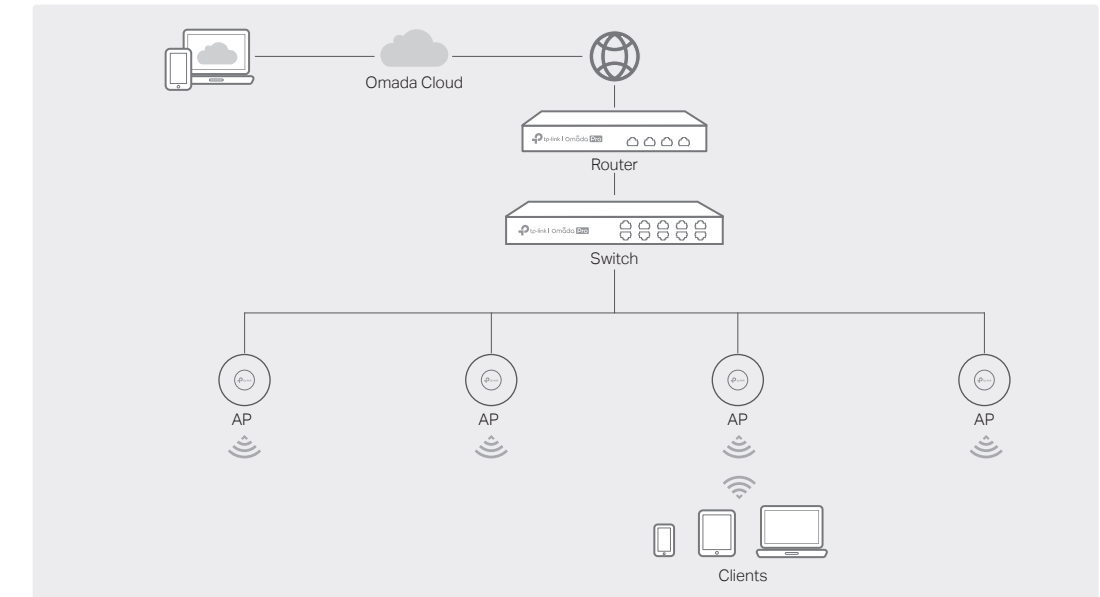

- Note:**
- Before you start, be sure to **power up** and **connect** your devices according to the topology figure.
  - A **DHCP server** (typically a router with DHCP function enabled) is required to assign IP addresses to the APs and clients in your local network.

#### Web Configuration

1. Contact the sales staff to grant the Omada Pro Cloud-Based Controller permission.
2. Launch a web browser and enter <https://omada.tplinkcloud.com> in the address bar. Log in with your TP-Link ID.
3. Click + **Add Controller** and choose **Cloud-Based Controller** to add a Omada Pro controller. Then you can launch the controller to adopt and manage devices.

#### \* Management via Omada App

After adding a controller, you can also use it via the Omada app.

1. Download and install the TP-Link Omada app from App Store or Google Play.

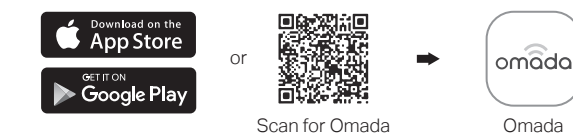

2. Launch the Omada app and log in with your TP-Link ID. Then go to **Cloud Access**. A list of controllers that have been bound with your TP-Link ID will appear. Then you can launch the controller to adopt and manage devices.

For the detailed configurations, refer to the User Guide of the controller and APs. The guides can be found on the download center of our official website: <https://www.tp-link.com/support/download/>.

To ask questions, find answers, and communicate with TP-Link users or engineers, please visit <https://community.tp-link.com> to join TP-Link Community.

For technical support, the user guide and other information, please visit <https://www.tp-link.com/support>, or simply scan the QR code.



#### Safety Information

- Keep the device away from water, fire, humidity or hot environments.
- Do not attempt to disassemble, repair, or modify the device. If you need service, please contact us.
- Do not use the device where wireless devices are not allowed.
- Do not use damaged charger or USB cable to charge the device.
- Do not use any other chargers than those recommended.
- Adapter shall be installed near the equipment and shall be easily accessible.

