

Quick Start Guide

Smart Floodlight Camera

*Images may differ from actual products.
©2024 TP-Link 7106511192 REV1.0.0

Before You Start

- WARNING: Risk of Electric Shocks**
- Disconnect power at the fuse or circuit breaker before installing.
 - Verify that the power supply voltage is correct. Connect fixture to a 110-240 VAC 50/60 Hz power source.
 - Always follow code standards when installing wired connections.
 - Install only on a UL-listed junction box or on a wall with a Neutral wire and a Line wire.
 - An all-pole mains switch shall be incorporated in the electrical installation of the building. And the contact separation of the switch shall not be less than 3 mm.
 - You can always find detailed wiring and mounting instructions in the Tapo app.



If you are unfamiliar with basic electrical wiring, please consult a licensed electrician.

NOTICE

- Do not install near combustible or flammable surfaces.
- Do not connect this light fixture to a dimmer switch or timer.

01 / Mounting Options

You can mount your smart floodlight camera vertically on a wall or overhang under an eave. Make sure the area has a strong Wi-Fi signal.

*Recommended Mounting Height: 2.5-3 m (8-10 ft) above the ground

For Wall Mount

Ensure the UP arrow on the bracket points up.

*To install horizontally, adjust the bracket to ensure the air bubble in the level is centered.

For Eave Mount

Point the UP arrow on the bracket towards your house.

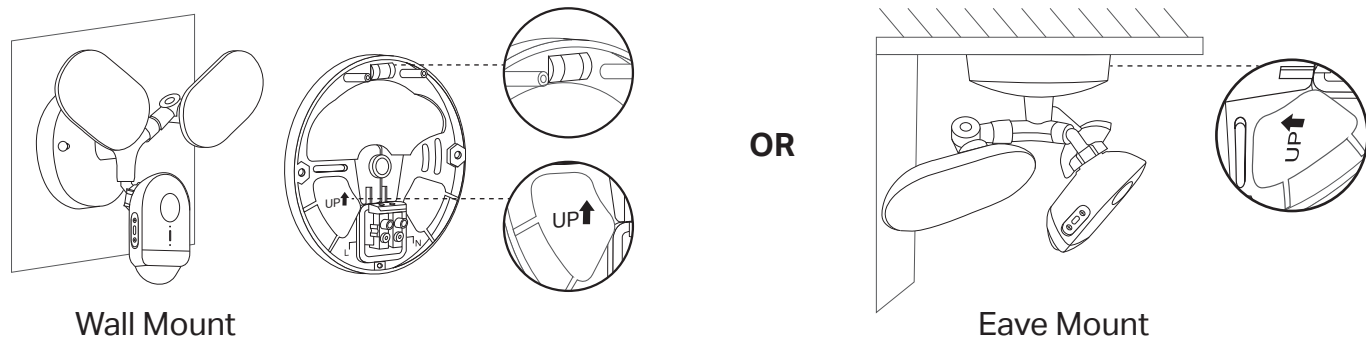

02 / Connect Wires and Install Floodlight Camera

⚠ Take care to avoid electric shocks.

*Wire colors vary by region. If you are unfamiliar with basic electrical wiring, please consult a licensed electrician.

*You can insert a microSD card for local recording before installation following the guidance on the back.

Option 1: Install on an existing junction box

The floodlight camera can be mounted on a junction box on a wall or under an eave.

Required Accessories:



1
Turn off the circuit breaker. Make sure the power is off by turning your light on and off a few times.

⚠ Take care to avoid electric shocks.

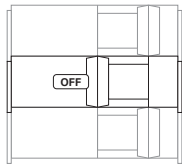

2
Remove the existing floodlight camera and disconnect wires from the junction box.

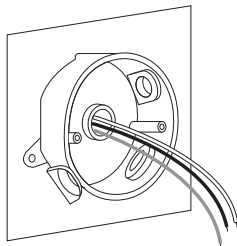

3
Choose a pair of plate screws based on your junction box. Install the mounting plate to the junction box.

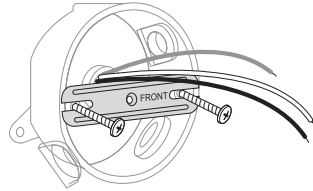

4
Cover the Ground wire (usually green/green and yellow) with a wire nut or insulating tape. Route the Neutral wire (usually white/blue) and the Line wire (usually black/brown/red) through the bracket.

Note: To identify wire colors, you can refer to <https://www.tp-link.com/support/faq/3474/>

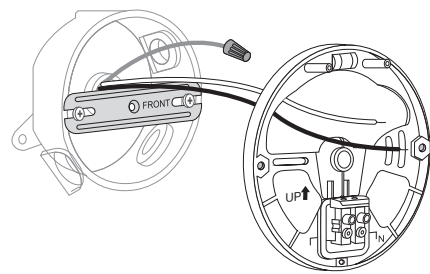

5
Connect the Neutral and Line wires (recommended strip length: 10-15 mm [0.4-0.6 in.]) to the silicone holes in the bracket. Secure the wires with a slotted screwdriver.

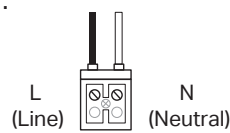

Note: Do not expose stripped wires outside the waterproof silicone holes. When the wires are too short, stiff, or soft to connect, you can refer to <https://www.tp-link.com/support/faq/3883/>

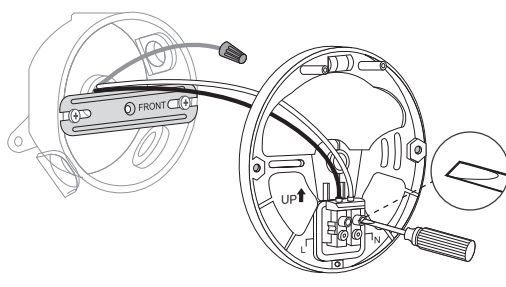

6
Hide the wires in the junction box. Attach the bracket to the mounting plate on the junction box with the bracket screw.

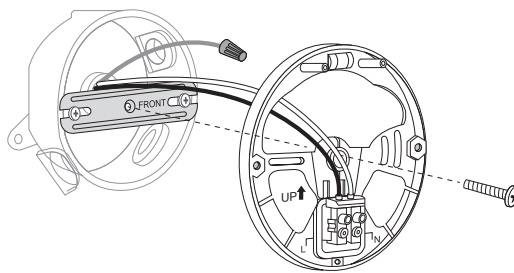

7
Insert the camera screws into the screw holes. Align the mounting posts on the bracket with the holes on the floodlight camera. Tighten the camera screws in the screw holes to secure the floodlight camera to the bracket. Insert the screw caps into the screw holes.

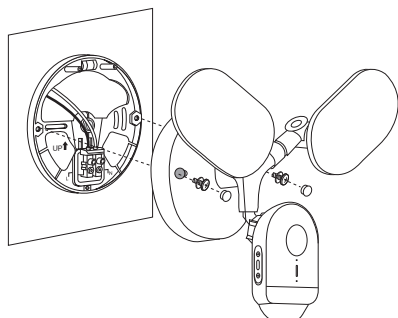

8
Apply waterproof glue between the Tapo device and the wall. Adjust the camera and light position to the desired angles.

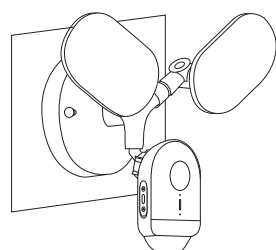

9
Turn on the circuit breaker. Wait until the System LED blinks red and green for setup.

Note: Floodlights are auto-on in darkness upon power-up. Avoid direct eye contact at close range to prevent eye injury.

Option 2: Install with existing electrical wires

Install where the Neutral wire and Line wire are available.

Required Accessories:

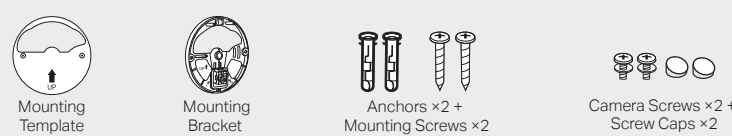

1
Turn off the circuit breaker. Make sure the power is off by turning your light on and off a few times.

⚠ Take care to avoid electric shocks.

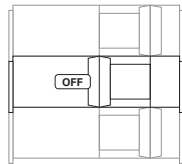

2
Route the wires through the mounting template and place the template. Drill two holes where indicated.

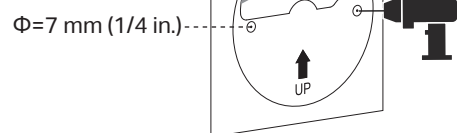

3
Insert two wall anchors into the holes. Route the wires through the mounting bracket. Use the screws to affix the bracket over the anchors.

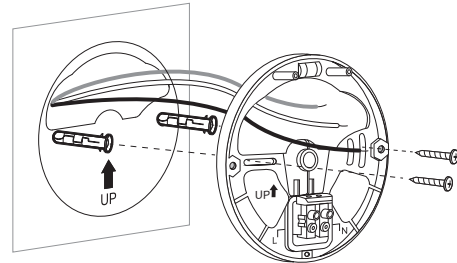

4
Cover the Ground wire (usually green/green and yellow) with a wire nut or insulating tape.

Note: To identify wire colors, you can refer to <https://www.tp-link.com/support/faq/3474/>

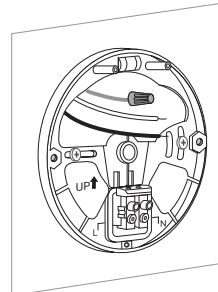

5
Connect the Neutral (usually white/blue) and the Line (usually black/brown/red) wires (recommended strip length: 10-15 mm [0.4-0.6 in.]) to the silicone holes in the bracket. Secure the wires with a slotted screwdriver.

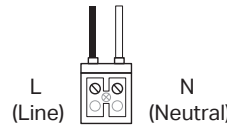

Note: Do not expose stripped wires outside the waterproof silicone holes. When the wires are too short, stiff, or soft to connect, you can refer to <https://www.tp-link.com/support/faq/3883/>

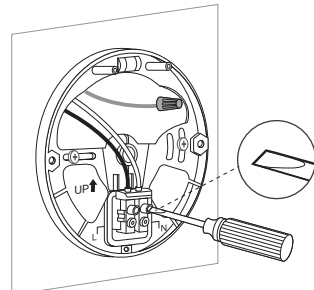

6
Hide the wires in the bracket. Insert the camera screws into the screw holes. Align the mounting posts on the bracket with the holes on the floodlight camera. Tighten the camera screws in the screw holes to secure the floodlight camera to the bracket. Insert the screw caps into the screw holes.

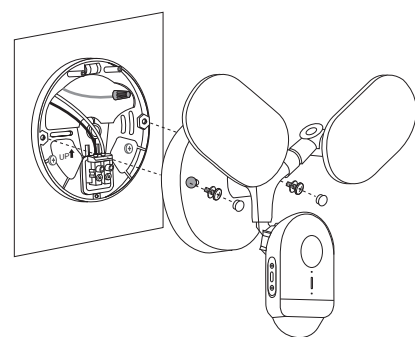

7
Apply waterproof glue between the Tapo device and the wall. Adjust the camera and light position to the desired angles.

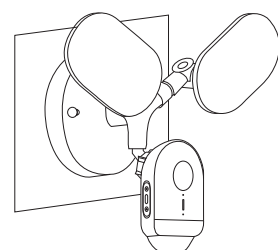

8
Turn on the circuit breaker. Wait until the System LED blinks red and green for setup.

Note: Floodlights are auto-on in darkness upon power-up. Avoid direct eye contact at close range to prevent eye injury.

03 / Set Up Floodlight Camera

1. DOWNLOAD APP

Download the **Tapo** app from the App Store or Google Play. Open the app and log in with your TP-Link ID. If you don't have an account, create one first.



2. SET UP CAMERA

Tap the ⊕ button > Add Device in the app and select your model. Follow the app instructions to set up your floodlight camera.

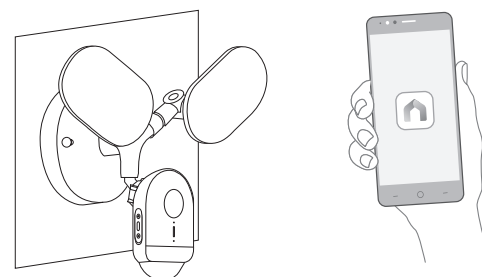

Appearance

Front

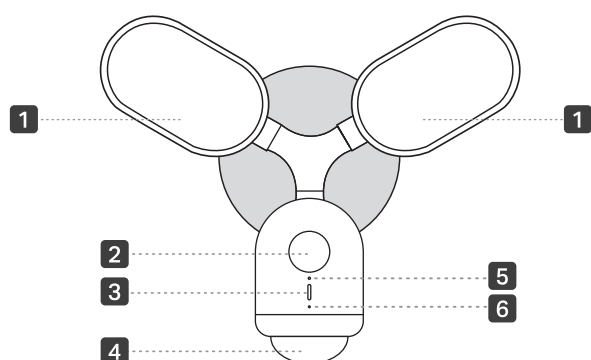

- 1 Floodlights
- 2 Camera Lens
- 3 System LED
- 4 Motion Sensor
- 5 Light Sensor
- 6 Microphone

Side

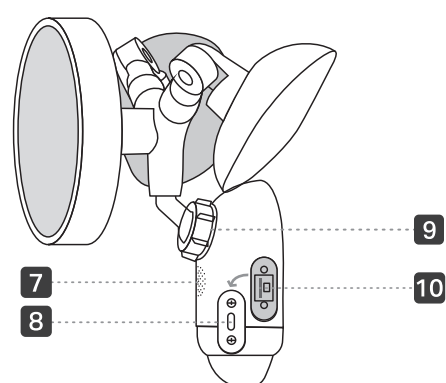

- 7 Speaker
- 8 Reset button
- 9 Camera Adjustment Knob
- 10 microSD Card Slot

Button Explanation

RESET Button

While the camera is powered on, press and hold the RESET button for at least 5 seconds until the System LED blinks red. The camera will reset and reboot.

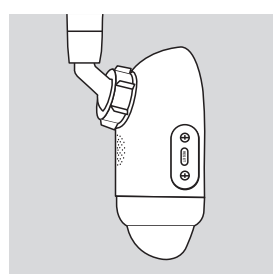

microSD Card Slot

Loosen the screws and insert a microSD card. Initialize it on the Tapo app for local recording.

*microSD card not included

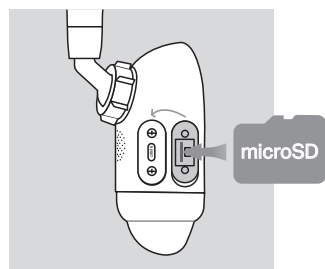

System LED Indication

Solid red	Starting up
Blinking red and green	Ready for setup
Blinking red slowly	Connecting to Wi-Fi
Solid amber	Connected to Wi-Fi
Solid green	Connected to TP-Link cloud server
Blinking red quickly	Camera resetting
Blinking green quickly	Camera updating

FAQ (Frequently Asked Questions)

Q1: How can I identify the wires?

A: Wire colors vary by region. The Neutral wire is usually white/blue, while the Line wire is usually black/brown/red.

You can refer to <https://www.tp-link.com/support/faq/3474/> for detailed information.

If you are unfamiliar with basic electrical wiring, please consult a licensed electrician.

Q2: What can I do if my floodlight camera cannot power on after wiring?

A1: Make sure you have turned on the circuit breaker.

A2: Check if the System LED is on. If it is off, turn off the circuit breaker and check the wiring.

A3: Refer to <https://www.tp-link.com/support/faq/3475/> for detailed instructions.

Q3: What if there is no existing junction box or electrical wires?

A: Floodlight cameras require high power supply and should be installed in a location with a weatherproof junction box or electrical wires.

If you do not have a current energy source or are uncomfortable dealing with electrical wiring, have an expert electrician do the job.

Safety Information

- Keep the device away from fire or hot environments. DO NOT immerse in water or any other liquid.
- Do not disassemble, repair or modify the product.
- Do not use the device where wireless devices are not allowed.
- Do not use the product if the casing has been broken. Danger of electric shock.
- Never touch the product with wet hands.
- It is NOT recommended to expose this product to heavy rain or any type of moisture.
- Do not place near automatically controlled devices such as fire alarms. Radio waves emitted from this product may cause such devices to malfunction resulting in an accident.
- Observe restrictions on using wireless products in fuel depots, chemical plants or when blasting operations are in progress.
- Do not use liquid to clean the product. Only use a dry cloth.
- Never put metal objects inside the product. If a metal object enters the product turn off the circuit breaker and contact an authorised electrician.
- This product is not intended to be used when providing medical care. Consult the manufacturer of any personal medical devices, such as pacemakers or hearing aids to determine if they are adequately shielded from external RF (radio frequency) energy.
- Do not use this product in health care facilities. Hospitals or health care facilities may be using equipment that could be sensitive to external RF energy.
- The product should be kept free from excessive smoke, dust or high temperature and vibration.
- Avoid direct sunlight for better performance.
- Do not place heavy objects on top of the product.
- This product may interfere with other electronic products such as TV, radios, personal computers, phones or other wireless devices.
- The light source of this luminaire is not replaceable; when the light source reaches its end of life the whole luminaire shall be replaced
- Operating Temperature: -20 °C ~ 45 °C (-4 °F ~ 113 °F)

Please read and follow the above safety information when operating the device. We cannot guarantee that no accidents or damage will occur due to improper use of the device. Please use this product with care and operate at your own risk.

TP-Link hereby declares that the device is in compliance with the essential requirements and other relevant provisions of directives 2014/53/EU, 2009/125/EC, 2011/65/EU and (EU) 2015/863.

The original EU declaration of conformity may be found at <https://www.tapo.com/en/support/ce/>

TP-Link hereby declares that the device is in compliance with the essential requirements and other relevant provisions of the Radio Equipment Regulations 2017.

The original UK declaration of conformity may be found at <https://www.tapo.com/support/ukca/>



Need some help?

Visit <https://www.tapo.com/support/> for technical support, the user guide, FAQs, warranty & more

