

Quick Start Guide

Dome Network Camera

*Images may differ from actual products.

Safety First:

- Make sure your power supply matches your camera. The camera's standard power supply is 12V DC or PoE (802.3af/at). The power source should comply with Power Source Class 2 (PS2) or Limited Power Source(LPS) of IEC 62368-1.
- Make sure that the wall is strong enough to withstand 4 times the weight of the camera and mounting bracket.
- If you are uncertain or uncomfortable performing the installation, consult a qualified electrician.

Package Contents

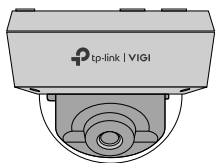

Network Camera

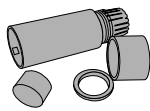

Waterproof Cable Attachments

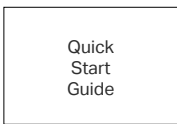

Quick Start Guide

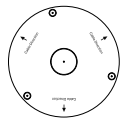

Mounting Template



Anchors & Screws

Appearance

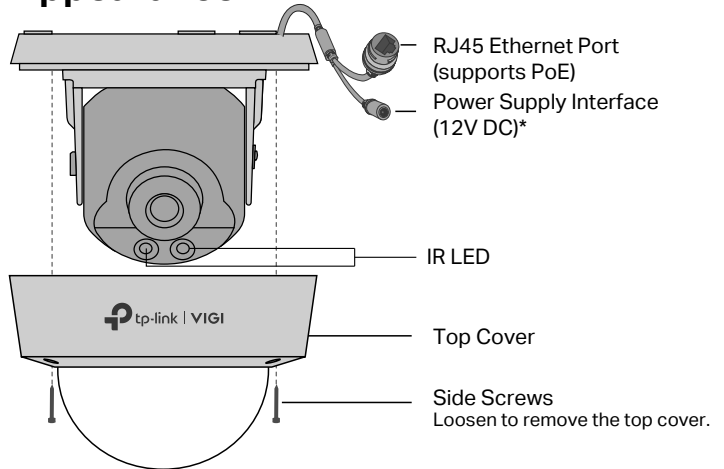

*Some models do not have the power supply interface. You can check the detailed specifications on the product page at <https://www.tp-link.com/>.

1 Mount Camera

1. Loosen the screws on the side of the camera to remove the top cover.

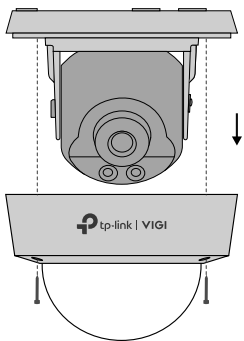

Remove the top cover

2. Decide how to route the cable through the ceiling/wall.

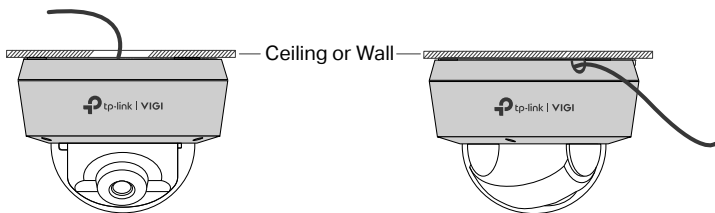

Route the cable through the bottom of the camera

Knock out the cable hole on the side and route the cable from the side

3. Stick the mounting template to the desired mounting place, and mount the camera. Pay attention to the cable direction.

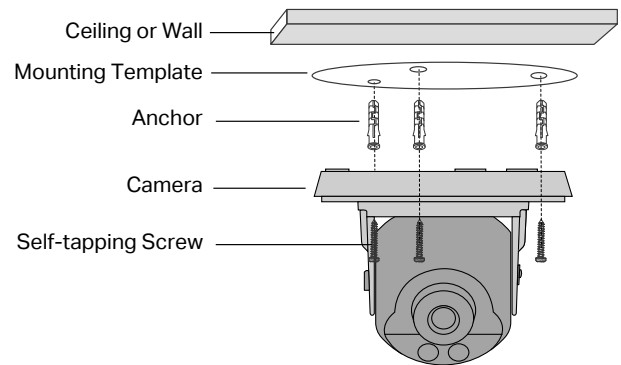

Mount the camera

4. Rotate the lens base or the dome to adjust the angle of the lens as desired. Tighten the side screws to secure the cover.

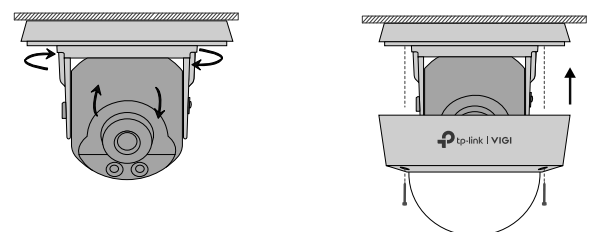

Adjust lens angle

Reinstall the top cover

Installing Waterproof Cable Attachments

Install the waterproof cable attachments for the network interface when the camera is installed outdoors.

Note: Make sure each part is securely attached and the waterproof rings are flush to keep out water.

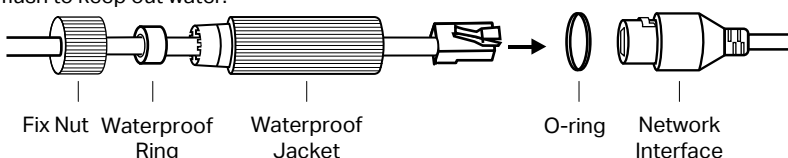

1. Route the network cable through the following components in order: fix nut, waterproof ring, and then the waterproof jacket.
2. Fix the O-ring to the network interface of the camera and connect the network cables.
3. Attach the network interface with the waterproof jacket, then twist to lock.
4. Insert the waterproof ring into the waterproof jacket. Rotate the fix nut to secure it to the waterproof jacket.

Done! The network interface is now waterproof.

2 Use Your Camera with an NVR

The camera works with an NVR for easier batch access and management.

*Here we use a VIGI NVR as an example.

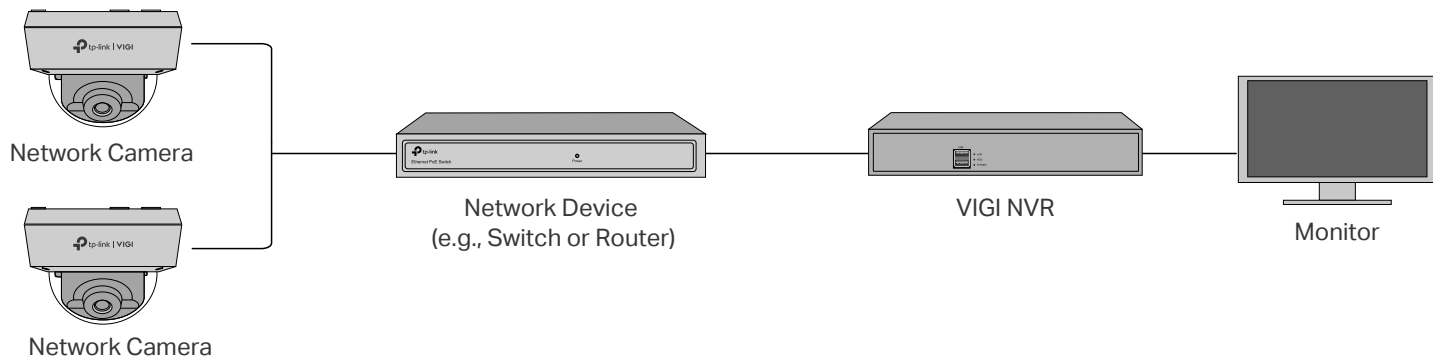

Step 1. Connect the Hardware

Connect your cameras to the same network as your NVR (as shown above).

Step 2. Power On the Cameras

Power on your cameras with the PoE power supply or an external power supply.

Note: Some models do not have the power supply interface. You can check the detailed specifications on the product page at <https://www.tp-link.com/>.

Step 3. Add Cameras with the NVR

Before you start, make sure the NVR is working properly.

1. Right click on the Live View screen and click **Add Camera**.
2. Select your camera and click **+** to add your camera directly. If you have disabled Plug and Play on your NVR, create a password or use a preset password for your camera.

Note: If you can't find your camera, refer to FAQ-Q1.

😊 **Done!** You can now view live video and manage cameras.

Using your cameras with other NVR brands:

Step 1: Power on your cameras and connect them to the network.

Step 2: Activate the camera using the **VIGI Security Manager** or **TP-Link VIGI** app (refer to the next section).

Step 3: Refer to the NVR's User Manual to add cameras.

More Management Methods

You can also access and manage your cameras via any of the methods below.

Method 1: Via the VIGI Security Manager (Windows only)

View live video and modify camera settings on your computer.

1. Download the **VIGI Security Manager** on your computer at <https://www.tp-link.com/support/download/vigi-security-manager/>.
2. Install the **VIGI Security Manager** and open it.
3. Cameras on the same network as your computer can be automatically discovered. Go to **Settings > Discovered Devices**, click **+** **Add** to activate your discovered cameras by setting passwords, and follow the instructions to add your cameras.

Method 2: Via the TP-Link VIGI App

Remotely view live video, manage cameras, and get instant alerts.

1. Download and install the **TP-Link VIGI** app.



2. Open the **TP-Link VIGI** app and log in with your TP-Link ID. If you don't have an account, sign up first.
3. Tap the **+** button on the top right and follow the app instructions to activate and add your cameras.

Method 3: Via a Web Browser

Note: Some models do not support web management. You can check the detailed specifications on the product page at <https://www.tp-link.com/>.

View live video and modify camera settings via a web browser.

1. Find the camera's IP address on your router's client page.
2. On your local computer, open a web browser and enter **https://camera's IP address** (<https://192.168.0.60> by default).
3. Select your Country/Region and Time Zone.
4. Set a password to activate the camera.

Done. You can view the live video on the Preview page, and go to the Settings page to change camera settings.

Frequently Asked Questions (FAQ)

Q1: What can I do if no cameras are discovered?

- Refresh to discover your camera again.
- Make sure the camera is powered on.
- Make sure your camera and NVR/computer are in the same subnet. If not, use the **VIGI Security Manager** to set camera's network parameters.
- Try to add your cameras manually.
- For other NVR brands, make sure you have activated the camera by setting a password via the **VIGI Security Manager** or **TP-Link VIGI** app.

Q2: How do I know the camera is powered on?

- The IR LED will turn on for about 10 seconds once the camera is powered on. If it's off, you can cover the lens for several seconds and check if the IR LED turns on.
- Check the LED status of the network device your camera is connected to.

For more questions, please refer to <https://www.tp-link.com/support/faq/2850/>

- Do not use any other chargers than those recommended.
- Do not use damaged charger or USB cable to charge the device.
- Do not attempt to disassemble, repair, or modify the device. If you need service, please contact us.
- Adapter shall be installed near the equipment and shall be easily accessible.
- Keep the device away from fire or hot environments. DO NOT immerse in water or any other liquid.
- The power adapter must be used indoors. Make sure that the temperature of the power adapter is within 0-40°C.

TP-Link hereby declares that the device is in compliance with the essential requirements and other relevant provisions of directives 2014/30/EU, 2014/35/EU, 2009/125/EC, 2011/65/EU and (EU)2015/863.

The original EU Declaration of Conformity may be found at <https://www.tp-link.com/en/support/ce/>

TP-Link hereby declares that the device is in compliance with the essential requirements and other relevant provisions of the Electromagnetic Compatibility Regulations 2016 and Electrical Equipment (Safety) Regulations 2016.

The original UK Declaration of Conformity may be found at <https://www.tp-link.com/support/ukca/>

